

Zappone Roofing System

Application Guide



ZAPPONE™
MANUFACTURING

Producing America's Premier Copper and Aluminum Shingles
Since 1969

Table of Contents

Subject	Page
Required Tools	2
Walking on Roof	2
Safety	2
Deck Preparation	2
Zappone Shingle and Common Accessories	3-4
Roof Jacks	7
Step-By-Step Application:	
1. Roof Inspection	5
2. Starter Strip Installation	5
3. Underlayment Application	5
4. Valley Installation	5
5. Gable-End Installation	7
6. Shingle Application	7-14
7. Hip and Ridge Cap Installation	13

Note:

This application guide has been prepared and is offered by Zappone Manufacturing as a service to professional contractors and the “do-it-yourself” homeowner with the assumption and caveat that common sense and accepted safety practices will be utilized.

These procedures and techniques are not intended to substitute for any local, state or national building codes or safety requirements. It is highly recommended that the appropriate authorities be contacted for any requirements specific to the intended installation.

As always when working with metal products, care must be given to avoid injury from cuts and abrasions. Also, working on roofs is inherently dangerous. It is recommended that the proper safety equipment and attire be worn.

Zappone Manufacturing assumes no responsibility for improper installation, property damage, or personal injury that may result from working with this product and these guidelines.

Tools

Zappone Roofing Systems are easily applied by both professional contractors and “do-it-yourself” homeowners. This list of require tools is minimal and includes:

Hammer	Tin Snips
Tape Measure	Hand Seamer
Ladder	Utility Knife

Walking on Roof

The interior of Zappone Shingle is a recessed area, the “shadow-cup”, which rests flat against the deck. This eliminates the air space that makes other metal roofs so noisy and allows for walking on the roof when necessary. Be sure to stay within the recessed area of the shingle and do not walk on the interlocking edges.

Safety

It is impossible for Zappone Manufacturing to be completely aware of all local requirements in all regions. Therefore, nothing in this booklet should be construed as to be contrary to any required safety regulation, procedure or device. Good common sense must be utilized whenever one works on a roof or uses a ladder. Please contact your local authorities for safety requirements.

Deck Preparation

Depending on applicable local codes, a Zappone Roofing System may be installed over existing composition roofing. Care should be taken to remove any "curled" or uneven composition shingles and to provide as flat a surface as possible. The system may not be applied over existing wood shake, other metal roofing or over any roof that may prevent smooth and even application. These roofs would need to be removed from the deck prior to application of the Zappone Roofing System.

The system requires “solid” decking (no spaced decking), an underlayment of minimum of No. 30 Felt and a minimum slope of 3:12.

Zappone Shingles and Accessories

Zappone Shingle ZR-100/ZR-100C

Available in copper and aluminum the shingle measures 15"x 9-1/8", with an exposure of 14-1/2"x 8-1/8". The aluminum shingles are packed 124 pieces to a carton and a carton covers 100 sq. ft. The copper shingles are packaged 62 pieces to a carton and a carton covers 50 sq. ft. The nailing flange contains two holes for the fasteners.

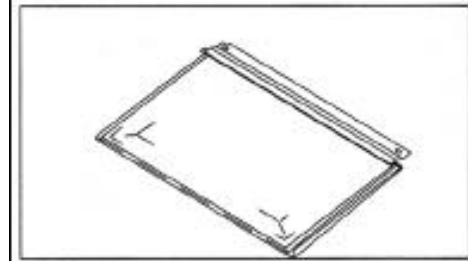

Starter Strip ZR-125

Produced in 8' lengths and applied at the eave edge. The starter strip doubles as drip metal and interlocks with the first course of shingles.

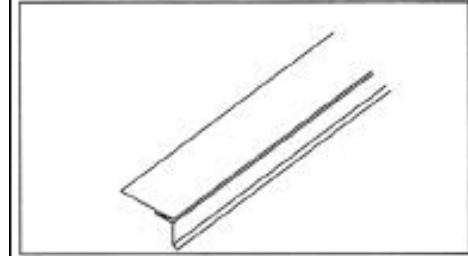

Continuous Valley ZR-240

Produced in 8' lengths. It interlocks with shingles to provide a leak proof condition.

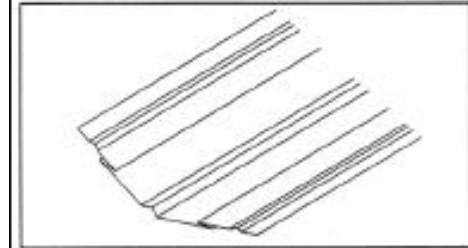

Hip and Ridge Caps ZR-145

Sold per piece. Each cap has 9-1/2" coverage. Applied on both hips and ridges. A continuous ridge in 8' lengths for commercial application is also available upon special request.

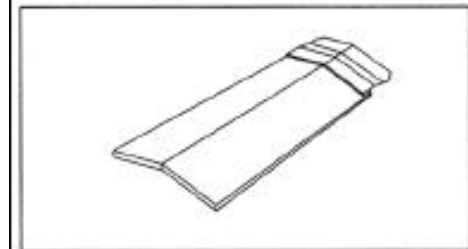

End Wall ZR-135

Produced in 8' lengths. Utilized to flash the eave side of chimney, skylights, solar panels and other protrusions requiring enclosure at the roof's surface.

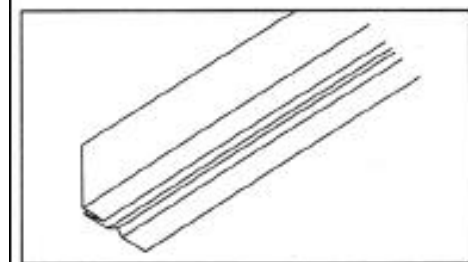

Side Wall ZR-140

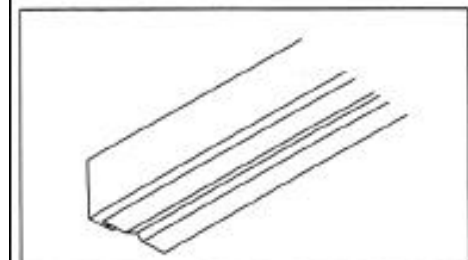

Produced in 8' lengths. Utilized to flash the ridgetside and gable/hip sides of chimney, skylights, solar panels and other protrusions requiring enclosure at the roofs surface.

**Gable End
ZR-130**

Produced in 8' lengths and applied to gable end/ rake conditions.



**Coil Stock
ZR-150**

50'x16" coils available in aluminum and copper. 12" coils available in copper only.



**Touch -up Paint
ZR-2160**

Sold by pints and quarts and available in all Zappone aluminum colors. Applied to cover application caused by scratches and to paint roof vents and other small protrusions to match shingle color.



**Aluminum Nails
ZR-164**

Screw shank. Specify 1-1/4" or 1-3/4" Sold per pound. For use with aluminum product only.



**Copper/Silicon Bronze Nails
ZR-164C**

Ring Shank. Specify 1", 1-1/4", 1-3/4" or 2-1/2" Solder per pound. For use with copper products only.

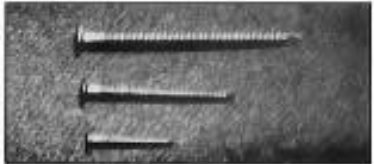

**Roof Vent Flashing
ZR-155 to ZR-158**

Available in aluminum and copper. Specify 1" to 1-1/2", 2" to 2-1/2", 3" to 3-1/2", 4" to 4-1/2".



**Hand Seamer
ZR-200**

Hand operated tool for creating bends in metal shingles when needed for installation with valleys, gable ends and side wall.



Step-by-Step Application

Step 1. Roof Inspection

Roof must have a minimum slope of 3:12 (Fig. 1). Deck must be solid with a minimum thickness of 1/2" for plywood or 7/16" for wafer board and applied in accordance with manufacturer's specifications.

If an existing roof is being covered, eliminate all curled and loose shingles, bumps, buckles and anything that might interfere with the smooth application of the Zappone Roofing System and the interlocking mechanisms that provide the water-tight characteristic of the Zappone shingle.

Caution: Prevent Electrolysis. Use care to prevent any dissimilar metals or corrosive nonmetallic materials from coming into direct contact with the metal shingles and accessories, particularly in area that may become wet. Do not allow water to flow from dissimilar metals to the shingles.

Step 2. Install Starter Strip

Install the starter strip along the eave edge by nailing 6" on center and keeping the strip straight. At adjoining sections, notch nailing flange back one inch from end (Fig. 2) and overlap the preceding starter strip. Nail within 1" to 2" of eave in a zig-zag pattern. (Fig. 3)

Step 3. Apply Underlayment

Apply an underlayment of No. 30 felt. Underlayment is required when covering an existing roof as well as when installing on bare deck. Start at the eave edge and roll felt parallel to eave edge, making sure the starter strip upper flange is covered. (Fig. 4)

Continue to apply and overlap felt as recommended by the manufacturer.

Some local codes require a second layer of felt or a thicker underlayment at the eave edge to a point beyond the bearing wall. Contact your local authorities for the requirements in your area.

Step 4. Install Valleys

Install the continuous valley so that it covers and extends slightly beyond the starter strip. (Fig. 5) Nail 10" on center in nailing flange.

When more than one continuous valley piece is required, overlap the upper piece over the lower piece by 3" - 6" and seal with mastic. (Fig. 6)

If a valley intersects a ridge, cut and bend the continuous valley so that it overlaps the ridge. If two valleys meet at a ridge, cut and bend the end of both valley pieces so that the first overlaps the ridge and the second valley piece then overlaps the first valley piece.

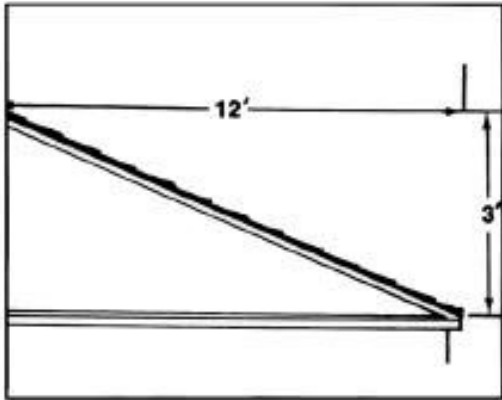

Fig. 1



Fig. 2



Fig. 3

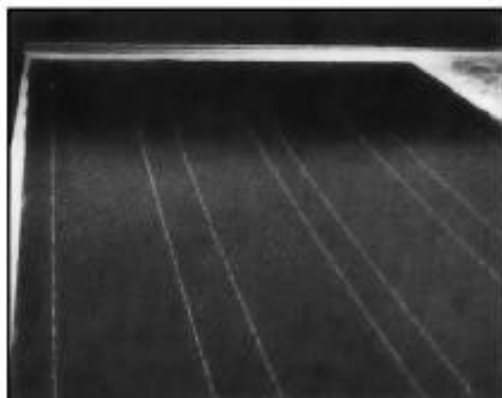

Fig. 4

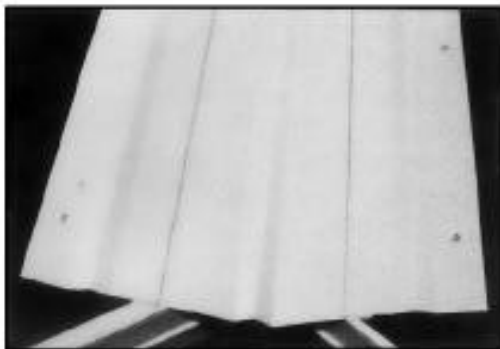

Fig. 5



Fig. 6

Step 5. Install Gable End

Install the gable end overlaying the starter strip. (Fig. 7) Place the fascia leg firmly against the gable-side fascia and fasten by nailing 10" on center in the nailing, flange.

When placing a number of gable-ends in succession you may either butt the pieces together or notch (Fig. 8) and overlay the pieces. (Fig. 9)

Step 6a. Shingle Application

Install shingles from left to right beginning at the lowest left-hand corner of any area to be covered. When working with a gable style roof, trim the first shingle to remove the left side tapered lock and notch the nailing flange and butt 3/4". Using a hand seamer, make a 90 degree downward bend creating a 3/4" downward face on the left side of the shingle. (Fig. 10) Place this face into the receiving slot of the gable end and lock the butt of the shingle into the starter strip. Press the shingle firmly upward and fasten by nailing through the holes provided in the nailing flange. (Fig. 11)

When working with a hip style roof, trim the first shingle diagonally so that it aligns with the center of the hip. Lock the shingle butt into the starter strip, press firmly upward and fasten by nailing through the holes provided in the nailing flange.

Whether gable style or hip style, continue applying shingles left to right, placing tile projecting tab on the upper left of each shingle into the corresponding groove on the upper right of the preceding shingle.

Rather than continuing each course the full length of the roof, after installing five or six shingles work upward within your reach by beginning three or four more courses. Work this pattern from left to right adding more upper courses as you work farther to the right. (Fig. 12)

To set the splits appropriately, start the second course and then each alternating course with half a shingle. (Note: When trimming shingles, most remaining pieces can be used later. Try to save them in a box separate from the scrap)

A Word About Roof Jacks

The Zappone shingle can easily be jacked, if necessary, on steep roofs. First, secure the Jack to the deck in accordance with manufacturer's specifications, then roof over the jack. Make two cuts in the hook of the shingle's butt equal in distance to twice the width of the jack. Bend the bottom portion of the hook between the cuts upward to allow jack to protrude from beneath the shingle.

To remove, push upward on the bottom of jack until it slides out from under fasteners and pull out from under shingle. Re-bend straightened portion of the hook and lock into place.

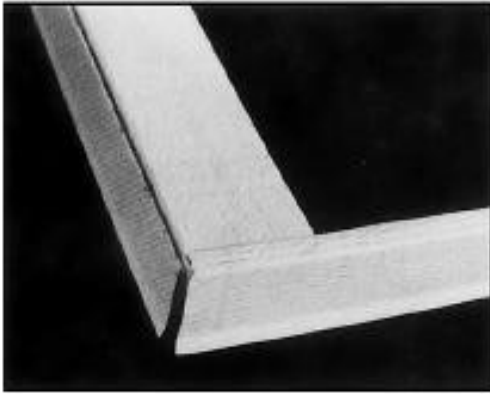

Fig. 7

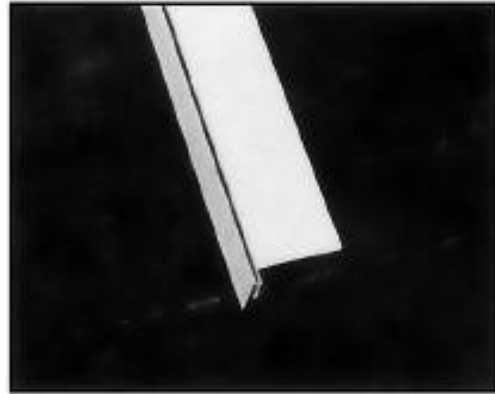

Fig. 8

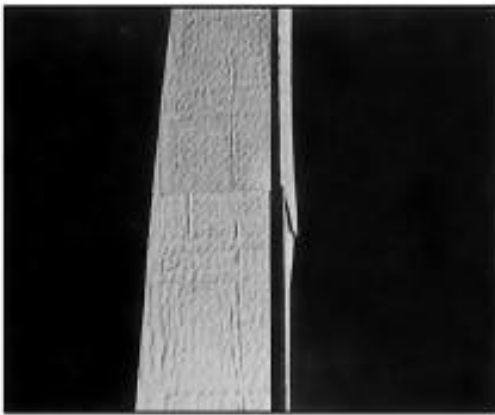

Fig. 9

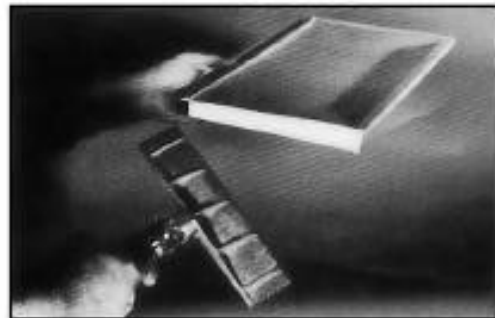

Fig. 10



Fig. 11



Fig. 12

6b. Shingle Application at End of Course

When ending a course at a gable end , lay the last shingle in place extending over the gable end and make a mark on the shingle at a point $\frac{3}{4}$ " beyond the gable end. Trim the shingle at this mark and create a downward face on the right side of the shingle by notching the nailing flange and butt and bending tile remainder as was done on the first shingle starting at a gable-end. Place the downward face into the receiving slot of the gable-end piece, lock the butt of the shingle firmly in the starter strip and fasten in place. (Fig. 13)

When ending a course at a hip , lay the last shingle in place extending over the hip and make a mark on the shingle at a point 2" beyond the center of the hip. Trim the shingle at this point and at a diagonal matching the direction of the hip. Lock the shingle firmly in place and bend the portion that extends over the hip firmly down on to the deck and any shingle that may have been installed on the other side. (Fig. 14)

The installation of the hip/ridge cap, described later, will conceal this procedure.

6c. Shingle Application at the Ridge

When reaching the ridge, lay the last course in place extending the shingles beyond the ridge. Make a mark on the shingles at a point 2" beyond the center of the ridge and trim the shingles at that mark. Lock the shingles firmly in place and bend the portion that extends over the ridge firmly down on to the deck and any shingle that may have been installed on the other side. Again, the installation of the hip/ridge cap, described later, will conceal this procedure.

6d. Shingle Application at Valleys

Coming into a valley:

Lay the shingle which will transect the valley into place and make a mark on the shingle at a point $\frac{3}{4}$ " beyond the left valley "S" lock. Trim the shingle at this point and at a diagonal matching that of the valley. Notch the right side nailing flange and shingle butt back $\frac{3}{4}$ ".

Using a hand seamer, bend the trimmed $\frac{3}{4}$ " 90 degrees downward. Measure $\frac{3}{8}$ " up the newly bent downward face and make a second 90 degree bend inward, toward the shingle. Lock this new under-fold into the valley "S" lock and nail shingle in place. (Fig. 15)

For shingles running out of the valley, simply use the above process on the left side of the shingle.

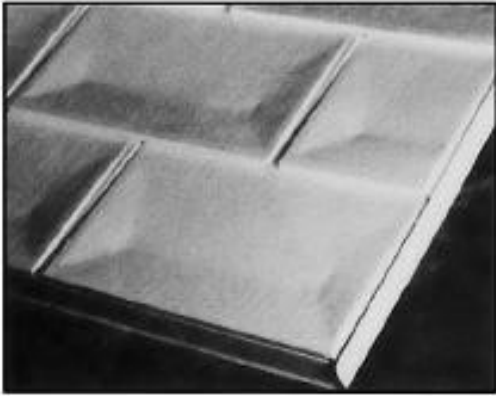

Fig. 13



Fig. 14

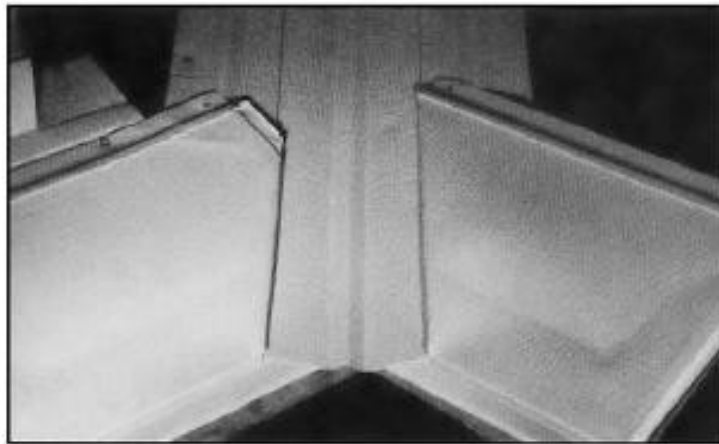

Fig. 15



Fig. 16



Fig. 17

Step 6e. Shingle Application at Plumbing Vents

Apply shingles from below up to the plumbing vent in normal fashion. Install vent flashing overlapping the shingles below the vent. (Fig. 16) Install shingles above the vent, cutting as necessary to ensure a tight fit around the collar of the vent. (Fig. 17) On low slope roofs, a piece of adhesive backed ice and water shield can be placed on the underside of the shingles that sit on the top (ridgeside) side of the vent.

6d. Shingle Application Around Chimney/Skylight/Dormer, etc. (Roof to Wall Conditions)

Install end-wall and side wall pieces around the protrusion. Apply end-wall pieces to those areas below (eave-side) of the protrusion (Fig. 18) and sidewall piece to those areas on the sides (Fig. 19), and above (ridge-side) of the protrusion. (Fig. 20)

Shingles Below Protrusion

Trim shingles at the top to assure a tight fit when inserted into the end-wall channel. (Fig. 21) Fasten shingle to deck as closely as possible to the inside of the end-wall channel. Cover nail head with mastic and touch-up paint.

Shingles to the Side of Protrusion

Trim shingle so that it extends beyond side wall "S" lock $3/4$ ". Notch back nailing flange and butt $3/4$ ". Using a hand seamer, bend the remaining trimmed portion of the shingle 90 degrees downward. At a point $3/8$ " up this newly bent face, make a second 90 degree bend inward, towards the shingle. This creates the "male" of an "S" lock. Lock the shingle into the side wall and fasten to the deck. (Fig. 22)

Shingles Above Protrusion

If the courses do not work out so that a full shingle can be used above the protrusion while keeping the course straight, trim the bottom of the shingle so that the nailing flange lines up with the nailing flanges of the other shingles in the course and the bottom extends $3/4$ " beyond the side-wall "S" lock. Notch the left and right side-lock channels back $3/4$ ".

Using a hand seamer, bend the remaining $3/4$ " trimmed section downward 90 degrees. At a point $3/8$ " up from the bottom of this newly bent face, make a second 90 degree bend inward towards the shingle. Lock this newly created butt into the "S" lock of the side wall and fasten to the deck. (Fig. 23)

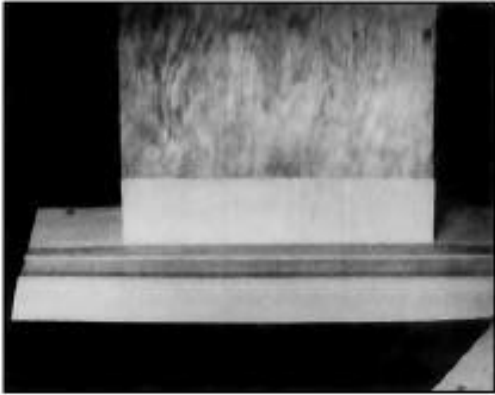

Fig. 18



Fig. 19



Fig. 20

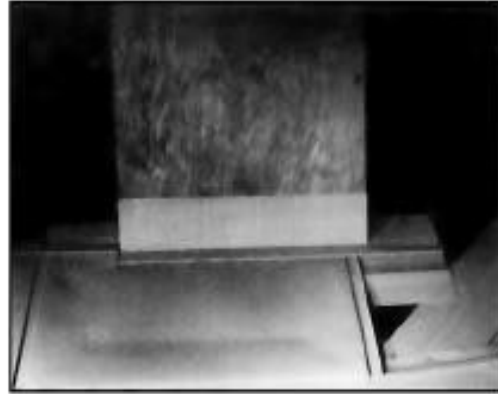

Fig. 21



Fig. 22



Fig. 23

Step 7. Install Hip and Ridge

When installing a hip style roof, install caps on all hips prior to the ridge.

Hips

To assist in a straight hip installation, snap a line from the bottom of the hip to the top. Using a hand seamer, straighten and flatten the "S" hook on the butt of the first hip/ridge cap. Place the cap at the bottom of the hip where two eaves come together. Extend the cap 3/4" beyond the corner created by the eaves. (Fig. 24) Scribe or draw diagonal lines on the cap from the center point to the sides, even with and parallel to the eave. Trim and fold the bottom of the ridge cap so that the new hooks created will fit in the "S" lock of the two adjoining starter strips (Fig. 25).

Lock the first cap into place and fasten with two nails in the nailing flange. (Fig. 26) The second and each subsequent cap will lock into the nailing flange of the cap below.

Ridges

Whether working on a gable style roof or a hip style roof, begin installing hip/ ridge caps on ridges by creating a "ridge cap starter strip". Trim the nailing flange from a hip/ridge cap and fasten it to the roof at either end of the ridge. (Fig. 27) Install the first ridge cap by locking it into the ridge cap starter and fastening it to the roof with two nails through the nailing flange. (Fig. 28) Continue installing the caps across the ridge in a like manner.



Fig. 24

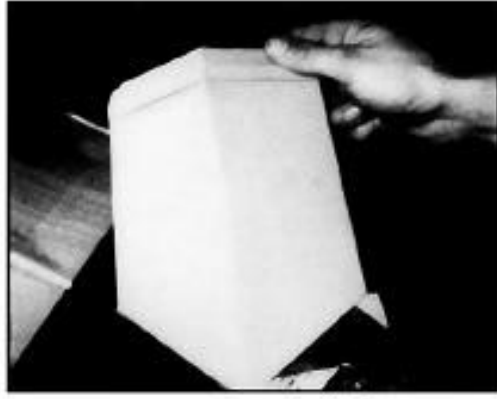

Fig. 25



Fig. 26

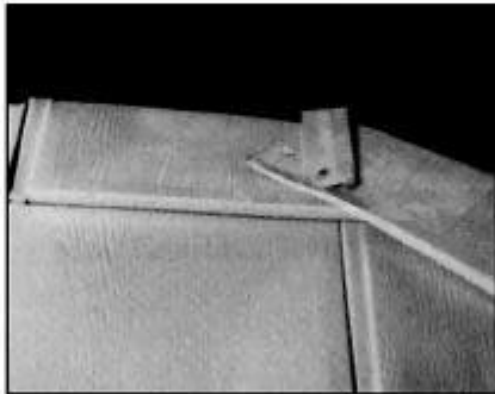

Fig. 28

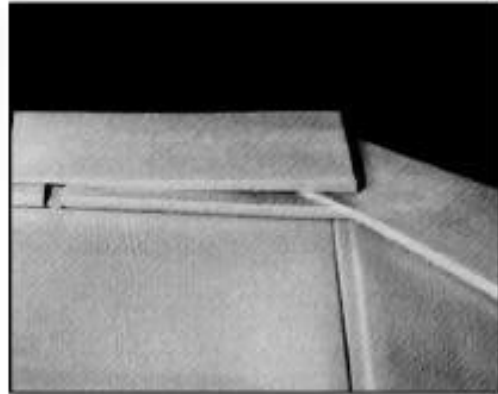

Fig. 29



N. 2928 Pittsburg St. · Spokane, Washington 99207
509.483.6408 · 800.285.2677
Fax: 509.483.8050 · E-mail: copper@zappone.com
Website: www.zappone.com

Zappone Manufacturing · Spokane, WA
Copyright 2000 All Rights Reserved

This document is protected against any unauthorized copying, duplication or reproduction in any manner.